



VAPROSHIELD[®]

Breathable Membrane Systems for Roofs & Walls

SLOPESHIELD[®] PLUS SELF-ADHERED

Air Barrier and Permeable Vapor Retarder Membrane

MOISTURE PROTECTION BEYOND THE SURFACE



REDUCING 90% OF AIR AND MOISTURE INFILTRATION



Relying on Staggered ISO as an Air Barrier Causes Moisture Intrusion

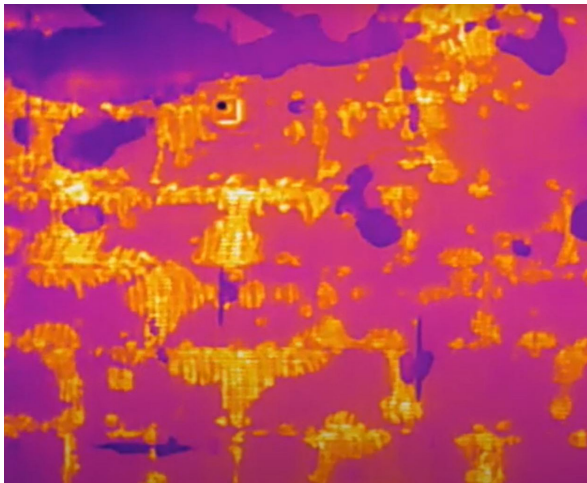

Extremely Wet Dry
The infrared image clearly shows moisture build-up beneath the roof membrane and within the roofing assembly.

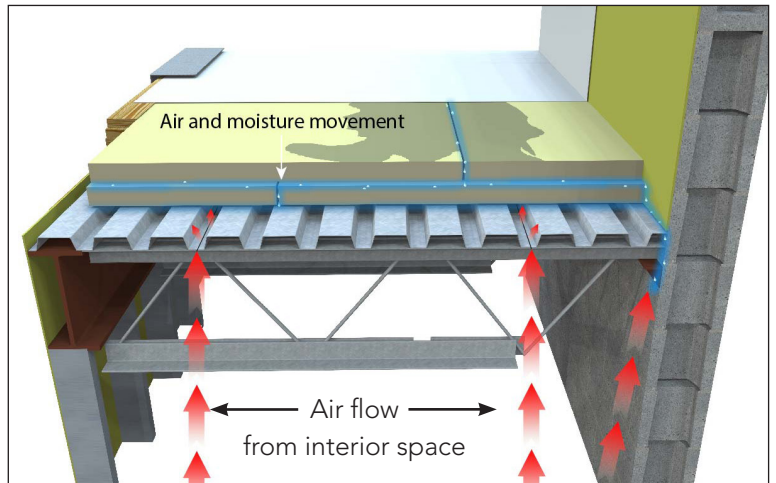

When staggered ISO or the roof membrane is used as an air barrier, moisture-laden air from the interior spaces will penetrate the roofing assembly, resulting in performance issues and water damage.

"When air moves, so does moisture...98% of moisture related issues are due to air movement."
-NRCA

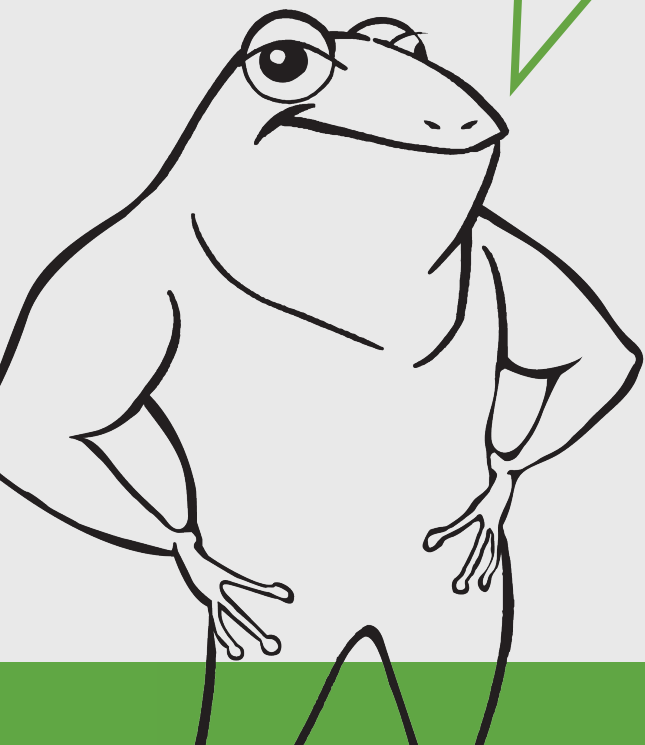

THE SLOPESHIELD PLUS

- A Roof Membrane
- B Thermal Barrier (insulation)
- C SlopeShield Plus SA functions as a dedicated air barrier and permeable vapor retarder membrane:
 - Reducing ~90% of air and moisture infiltration
 - Safeguarding from prolonged moisture-related damage
 - Enhancing building health and energy efficiency
- D Structural Deck

SOLUTION: MOISTURE-CONTROL MEMBRANE

SLOPESHIELD® PLUS SELF-ADHERED

NEW WAY TO ROOF

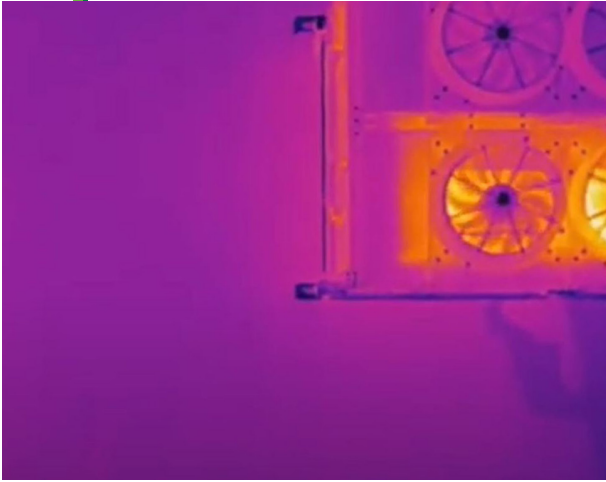

Extremely Wet Dry

This infrared image shows a **properly designed** and installed **moisture control strategy** for the roofing assembly.

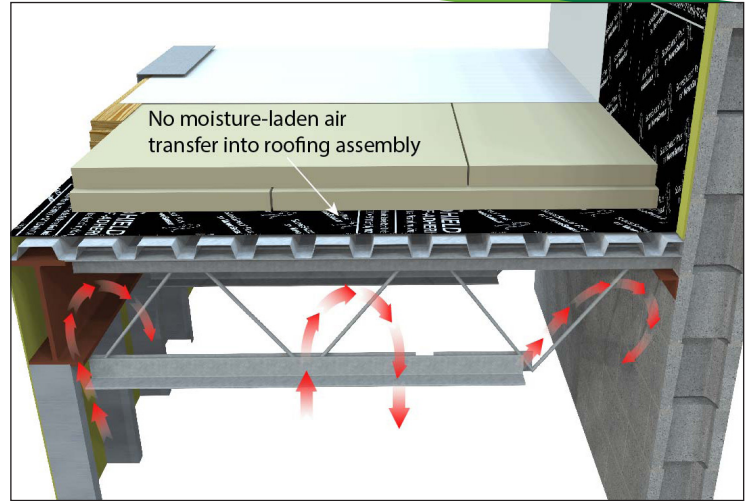

Implementing **SlopesShield Plus SA** during the design phase, as a moisture control layer, **blocks air and reduces moisture infiltration** up to ~90%, enhancing roof resiliency and integrity.

SA DIFFERENCE

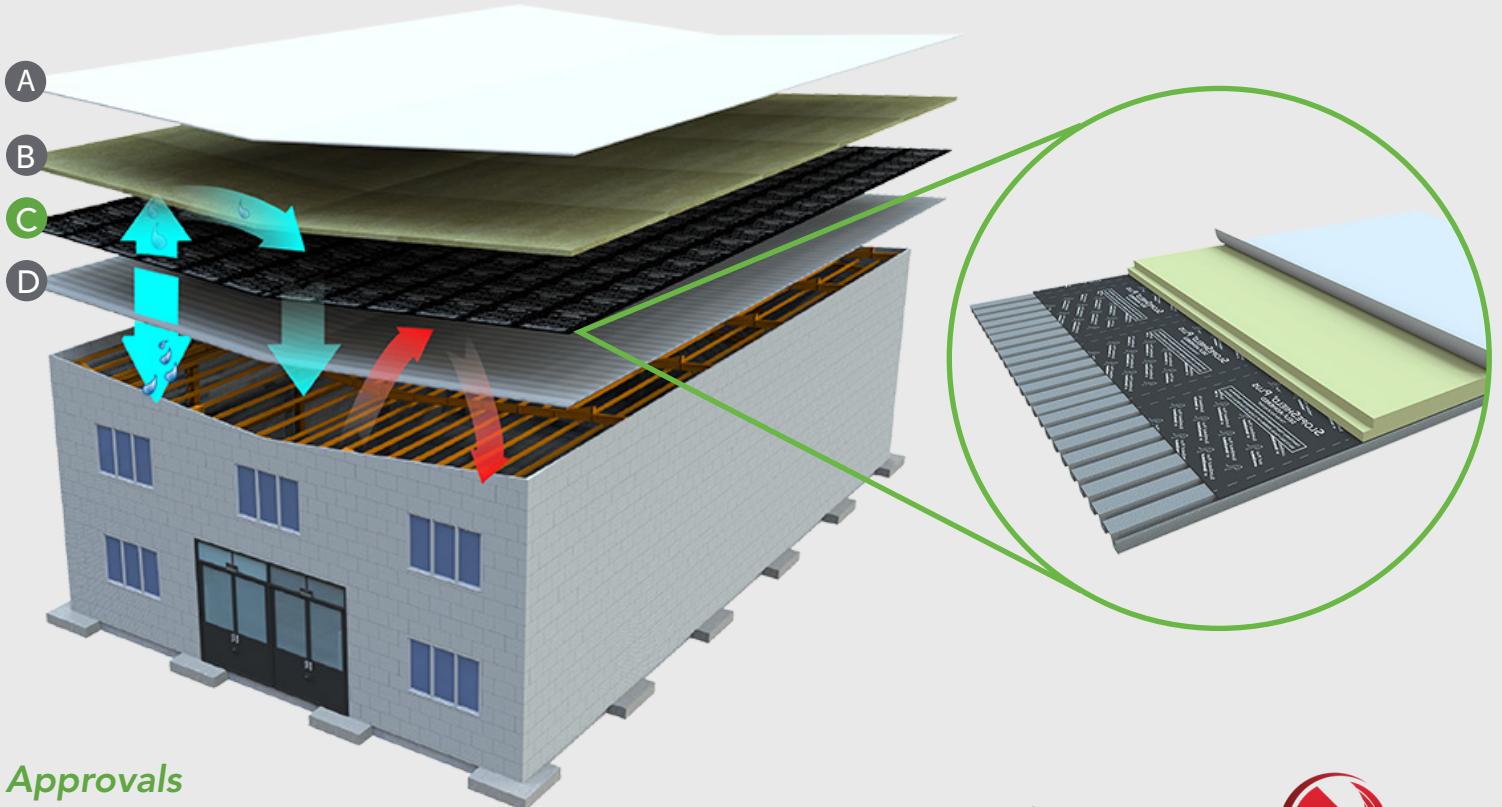

Approvals



BASE/PLY SHEET FOR ROOFING SYSTEMS AS TO AN EXTERNAL FIRE EXPOSURE SEE UL DIRECTORY OF PRODUCTS CERTIFIED FOR CANADA AND UL ROOFING MATERIALS AND SYSTEMS DIRECTORY (R40823)



SLOPESHIELD® PLUS SELF-ADHERED

MULTI-PURPOSE AIR BARRIER AND PERMEABLE VAPOR RETARDER



Municipal Library: SC

New Construction and Reroof



Newark Liberty International Airport,
Terminal C Roof Replacement: Newark, NJ

Recover/Renew



Food Processing Plant: Tipton, CA

Concrete Surface Protection

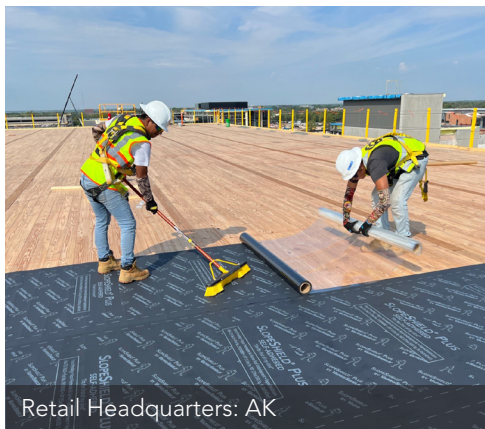

Retail Headquarters: AK

Mass Timber Surface Protection



Mewata Armoury: Calgary, AB

Steep Slope Underlayment



Private Residence: Burien, WA

Residential

ONE MEMBRANE: MANY SOLUTIONS

Contractor Benefits:

- Enhances work crew productivity, achieving building dry-in faster than conventional methods
- Easy installation: remove release liner, apply, and roll—no primer required
- Installs with common worksite tools
- Withstands heavy foot traffic and machinery
- Up to 180 days exposure to weather elements
- Offers temporary weather protection

Earn and Learn:

We invite you to learn more about SlopeShield Plus SA through our AIA-accredited webinar presentation.

Critical Choices:
Managing Air/Vapor in
Low Slope Roof Systems
(1LU/HSW, 1 IIBEC CEH)

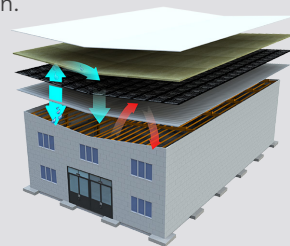

We invite you to continue the conversation about SlopeShield Plus SA multi-purpose roofing membrane with the VaproShield team. Specify SlopeShield Plus SA in DIV 07 as Your Preferred Code-Compliant Dedicated Air Barrier. Contact us at 866-731-7663 or visit us at VaproShield.com for your free sample.

